



【Model: FWK2231】

General Info

The advantages are as followings:

1. According to the characteristic of LED heat dissipation, the mechanical design and thermal principle are used to carry out to structural design of luminaires, combined with the material of high-thermal conductivity of high-purity aluminum alloy and the special processing technology, the effect of heat conduction, heat convection and heat radiation has been improved significantly, so that make “WuKong” Square series luminaire to achieve much more smaller, less weight, high light efficiency, energy saving, environmental protection and low carbon innovative products.

2. With super power LED, accurately control the scattered light, so that the LED light efficiency is much more higher, the center light intensity is much more stronger , which provides a perfect solution for short-distance projection lighting.

3. Integrated 12 ° shielding angle into the special design of luminaire.

Control: Standard DMX512 (1990) protocol compatible.

Application: Suitable for landscape lighting of the square, outdoor landscape, building facade, facade lighting of individual building and historical building, landscape lighting of green plant etc.

Technical parameter

Model	FWK2231
LED lifespan	50,000 hours
LED quantity	1PCS
LED color(color changing)	4 in 1 red/green/blue/white
Beam Angle(FWHM)	12° /15° /20° /30° /40° /55° /3015° /5030°
Shielding Angle	12°
Housing	Die-cast aluminum/aluminum alloy housing , dark gray powder paint with high corrosion resistance
Glass material	5mm thickness toughened ultra-white glass
LED driver	1000mA constant current driver
Power input	100 ~ 240VAC ± 10%,50/60Hz;24V DC
Power consumption	12W
Ingress protection	IP66
Power cable	3*1.0mm ² rubber cable(High voltage);2*1.0mm ² rubber cable(Low voltage)
Signal cable	CAT5-SFTP-4P(Controllable)
Control	DMX512(1990)
Classification	I;III
Anti-static	IEC61000-4(Level 4)
Ambient operating temperature	-20°C~+55 °C(Ta+10°C)
Power Factor(PF)	≥0.85
Inrush current(Max)	20A
Net weight	0.8KG

Dimension (mm)

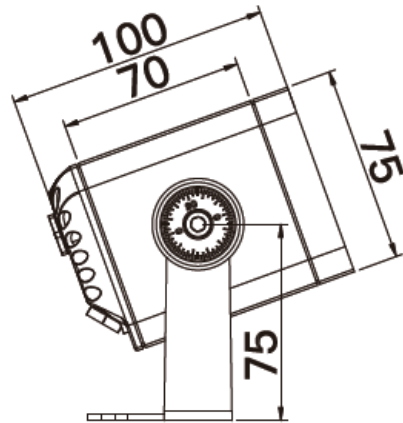
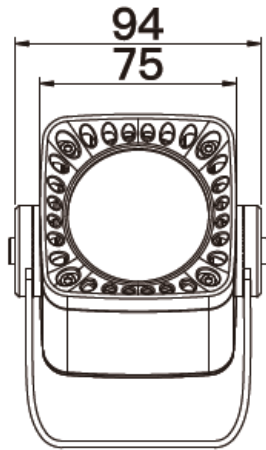

Shielding angle

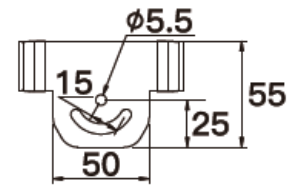
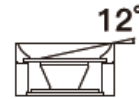

Accessories optional:
Outer light shield

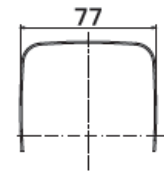
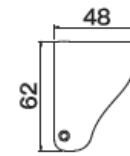

Accessories Optional

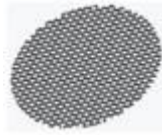

Outer light shield Honeycomb anti-glare net Deep cylinder anti-glare shield